



# Guideline

Tips and information on how to select the optimal hydraulic filter

## Guideline

Tips and information on how to select the optimal hydraulic filter



Return-Suction Filter E 198

### Preface

When determining the required cleanliness in a hydraulic system, additionally to the technical requirements of the hydraulic components and to the operating pressure, the user's expectations to availability, safety and service life of a machine become increasingly important. These aspects were particularly taken into account in the present ARGO-HYTOS guideline.

Detailed attention is also given to two filter concepts which are becoming increasingly important: return-suction filters and off-line filters.

More than ever before, the ARGO-HYTOS Guidelines offer useful advice on selecting technically and economically ideal filter concepts for hydraulic systems, and experts will also find that they contain important information.

#### Did you know that ...

- › fresh oil can often contain 10 times more dirt particles than are acceptable for hydraulic systems of high technical quality?
- › if the operating pressure is increased by only 50 %, the number of dirt particles in the oil must be reduced by a factor of 3 to avoid a deterioration in the lifetime of the components?
- › even a filtration quotient of  $\beta = 200$  corresponds to filtration efficiency of 99,5 % for all dirt particles that are larger than the specified size, and a  $\beta$ -value of only 10 still corresponds to 90 % efficiency?
- › even oil sample bottles declared as clean can contain considerably more dirt particles than the examined oil, if it comes from hydraulic systems with good filtration?
- › a lifetime of 1.000 service hours for a hydraulic filter corresponds to a mileage of about 60.000 km of a passenger car?
- › only an online count can determine the actual values for cleanliness classes < 10 (ISO 4406)?

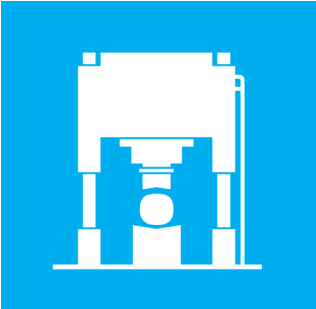

At ARGO-HYTOS, the focus is consistently on the customer – and a major element of our development work is to implement customer-specific solutions for filters and systems.

Continuous improvement of our filter elements is another major goal of our development work: for example, this includes increasing the dirt capacity while keeping the installed volume as small as possible. This optimization goal is excellently achieved by our range of standard return-suction filters – just one example of many.

Our sales engineers are just as reliable as our filters themselves. They are trained and experienced filter specialists who speak YOUR language. We believe that before the actual sales discussion there should be the best possible technical advice and assistance with planning if requested. This is the only way to ensure that our customers make the right purchase.

**Another benefit from ARGO-HYTOS:**

Spare parts can be delivered from our factories in the shortest possible time – and what is more, our subsidiaries in all important industrial countries and representatives all over the world always keep minimum stocks available. This ensures you rapid access to our know-how and our products.



Multi-Pass test rig

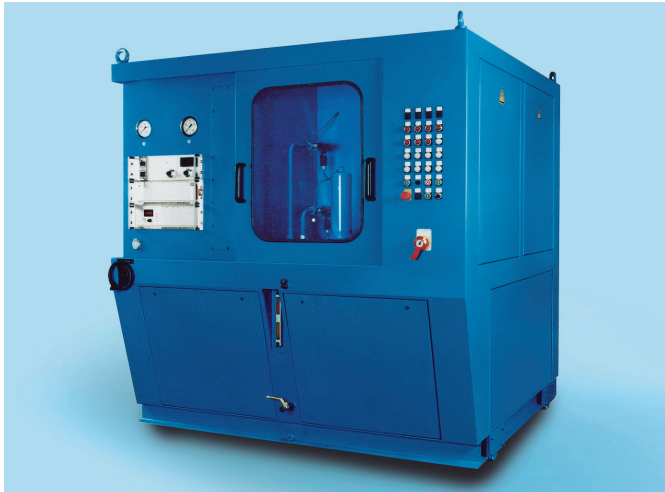

Collaps/burst pressure test rig



Test rig to determine pressure drop

The key feature of the entire hydraulics sector is that – for understandable reasons – users are setting demanding (and ever increasing) requirements for the quality and efficiency of the filters that are used. The testing technology used to develop filters must also meet these requirements. And this is where the difference between “filters” and ARGO-HYTOS filters emerges very clearly!

ARGO-HYTOS operates testing rigs that are equipped with ultra-modern technology, enabling fast test sequences, extended testing procedures and accurate documentation of all the parameters:

- › Multi-Pass test rig
- › Collapse/burst pressure test rig
- › Test rig to determine pressure drop
- › Test rig to prove the flow-fatigue resistance characteristics
- › Pressure pulse test rig to confirm fatigue strength

The ARGO-HYTOS Test Department is highly equipped with efficient testing equipment and human resources, and it plays a major part in the development of new technologies. Practical requirements can already be taken into account during filter trials in the test laboratory. Individual customer requirements are incorporated into the development process in the form of load tests which reflect practical conditions. The performance parameters of the test rigs we have installed allow us to test all filters throughout their performance ranges.

The state-of-the-art **Multi-Pass test rig** enables us to determine filter efficiency data according to ISO 16889.

The **collapse/burst pressure test rig** (for testing according to ISO 2941) is used to determine the specified permissible differential pressure; if this pressuredifference is exceeded, the element would be damaged.

The **test rig to determine pressure drop** in filters and their components (such as housings, filter elements and valves) is based on ISO 3968. It is suitable for testing the pressure loss in relation to the flow rate, and in relation to the kinematic viscosity. This also makes it possible to determine the pressure loss in a filter for unfavourable operating conditions – for example, at a cold start.

Here at ARGO-HYTOS, the **flow fatigue resistance characteristics** of filter elements are determined on the test rig according to ISO 23181, in such a way that a Multi-Pass test can be carried out afterwards. After the fatigue test, this means that the filter characteristics can be compared with the values of a new filter. Tests carried out on this rig are very important as they regard extending the intervals between filter element changes. Long-term loads of 1 million cycles or more may occur during practical use: these can be simulated within a short time on the test rig using a testing frequency of up to 1 Hz.

The **pressure pulse test rig** is used to validate filter casings to maximum pressure for lifetime, up to 5 weeks, in order to test fatigue strength – and this can be done up to 600 bar.

Alongside the laboratory tests, “field trials” are carried out at customers’ applications. The filters are put to the test in practice, under tough operating conditions. Thanks to these “field trials” which can often go on for months, even the smallest weak point is sure to be discovered. The result:

**ARGO-HYTOS offers tested quality and safety from A–Z.**



ARGO-HYTOS service vehicle in use



Portable oil diagnostic device OPCount

### The ARGO-HYTOS service vehicle

Oil cleanliness requirements are becoming stricter as time goes on. Filters are now expected to offer service lifetimes of 1.000 hours or more. Oils that stay clean not only extend the usual intervals between oil changes – they also prevent faults during operation, and they substantially extend the lifetimes of all the hydraulic components. Only in rare instances do we know how clean or dirty the pressure fluid in a hydraulic system really is. In many cases, the medium is only examined when a failure occurs or when damage is noticed. ARGO-HYTOS has developed its mobile customer service so that potential risks can be identified.

The ARGO-HYTOS service vehicle can travel to you whenever you need it. Oil samples can be analyzed on the spot, and we can determine the type and size of the dirt particles in the pressure fluid just a short time after the samples have been taken. This means that we can make appropriate suggestions about improving or redesigning the filtration in your hydraulic system while we are still on site.

Furthermore, the ARGO-HYTOS service vehicle plays a vital part in our development work resp. in carrying out on-site field tests.

### Oil diagnostic systems

Portable oil diagnostic systems make it possible for you, the user, to carry out oil analyses yourself on your own systems – at any time.

This instrument can be used in two different ways:

#### *Analysis of samples in bottles*

Small quantities of oil are taken from a suitable location in the system; the samples are filled in bottles and examined. Maximum cleanliness must be ensured both for the sampling process and the bottles themselves, so that the results of the measurements are not unintentionally affected by dirt from external sources.

#### *Online analysis*

Online analysis is based on continuous sampling with the help of a measuring hose – so external influences on the measured results can be virtually ruled out in this case. Depending on the sampling location, the oil diagnostic equipment must also be able to withstand the maximum system pressure, as well as to provide reliable measurements at low pressures.

The most important benefit of portable oil diagnostic systems is that the results are always available after just a few minutes. This means that any action that is needed can be initiated as quickly as possible. Convenient evaluation and documentation of the results is provided thanks to a PC interface and appropriate software, making it easy to identify any changes and trends.

It is possible to monitor the cleaning procedure by using oil diagnostic equipment in combination with mobile off-line filter systems. As soon as the desired level of oil cleanliness has been reached, the filtration process is stopped. This also makes it possible to fill systems with oil that has a defined level of cleanliness.

Permanently installed equipment for online oil cleanliness monitoring is ideal for cyclical monitoring of oil cleanliness in hydraulic and lubrication systems, and it also offers benefits in terms of preventive maintenance and early detection of damage in large systems. Suitable interfaces can be used to provide a direct link to the machine control system.



Suction filters



Return filters



Pressure filters



High-pressure filters

### The ARGO-HYTOS procedure for selecting a filter

The selection procedure described below makes it easy for you to select the right filters for hydraulic systems. To simplify matters, the procedure is broken down into these steps:

- › determine the right filter type
- › determine the filter fineness that is needed
- › determine the filter size that is needed
- › other considerations

This filter selection procedure is based on many years of practical experience with countless mobile and industrial hydraulic systems that are equipped with correctly chosen ARGO-HYTOS filters.

### How to determine the proper filter type

Unfortunately, there is no generally applicable concept which dictates the proper type of filter for each of the different hydraulic systems. To a large extent, the decision on whether to use suction, return, pressure or high-pressure filters – or a combination of these types – depends on these factors:

- › the contamination sensitivity of the components in the existing or planned system
- › the priority given to protect the function of the component, or to prevent wear
- › design or requirements of pumps, motors and valves, which may result in specified requirements from the component manufacturer
- › the way dirt is generated, the locations where it occurs and the possibility of ingress from outside

Depending on these factors, the criteria detailed below should be taken into account when you are choosing from possible types of filters. A basic distinction can be made here between protective filters that protect the function of components, and working filters that attain a specified level of cleanliness for the pressure fluid.

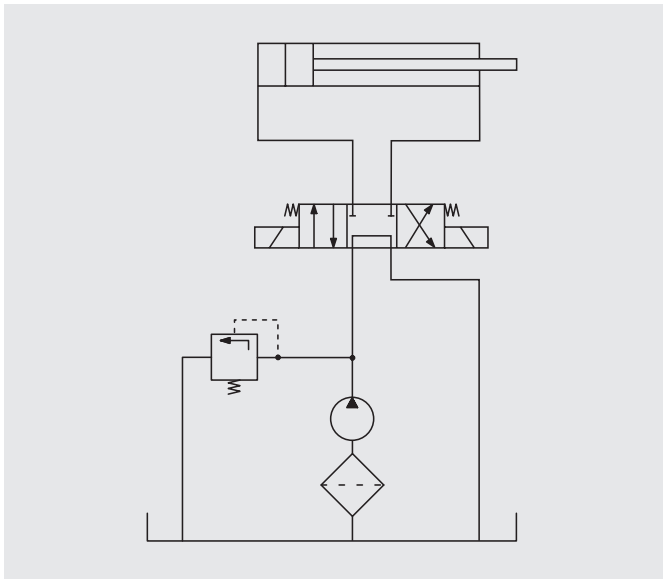

Figure 1: Hydraulic system with suction filter



Figure 2: Suction filter ES 075

### Suction filters

Hydraulic systems have to be fitted with a suction filter if there is a particularly high risk of damage to the pump from coarse contamination (Figure 1).

*Typical applications of this sort include:*

- › systems with a common oil reservoir for working hydraulics and gear transmissions.
- › units with oil tanks of large dimensions and/or complex shapes, or those which are welded or casted. Experience shows that 100% cleaning of the tank prior to assembly is impossible under these circumstances.
- › systems that are filled under difficult conditions in the field.

Often relatively coarse suction filters (e.g. screen filter elements with a mesh size of 40 - 125  $\mu\text{m}$ ) are planned that can only guarantee functional protection for the pump. In this case, the required protection against wear on the hydraulic components must be ensured by a finer filter at another location.

Specialized literature and company publications sometimes advance the opinion that the use of finer suction filters with paper or glassfiber elements is either impractical or inadvisable: however, this view is not tenable. Positive field experience – even with filter finenesses of 16  $\mu\text{m}$  abs. – in hydraulic systems (especially in the mobile sector) have demonstrated that these objections are not justified.

However, it is essential to consider the following criteria when designing a hydraulic system with a suction filter:

- › low pressure drop on the clean filter, due to optimal design of the filter element and housing, also taking account of high start viscosities
- › filter monitoring with a vacuum switch or vacuum manometer
- › the filter element must be easily accessible and simple to replace for maintenance purposes
- › the suction pipe should be designed with the lowest possible pressure drop, i.e. large nominal width (inner diameter), few and/or constant changes of direction (bent pipe instead of 90° fittings) and shortest possible length
- › the oil tank should be positioned higher than the pump (gravitation drop)
- › the system should be designed so that the planned operating temperature is reached as soon as possible after a cold start (tank volume should not be too large, oil cooler should be bypassed during the cold start phase)
- › the hydraulic oils used should have the lowest permitted viscosity and a low increase in viscosity if the temperature drops (high viscosity index)
- › the pump types used should not be very sensitive to cavitation (e.g. gear pumps).

ARGO-HYTOS's ES filter line offers a range of easy-to-maintain tank-mounted suction filters that have proven their excellence, especially in hydrostatic transmissions on mobile equipment (Figure 2).

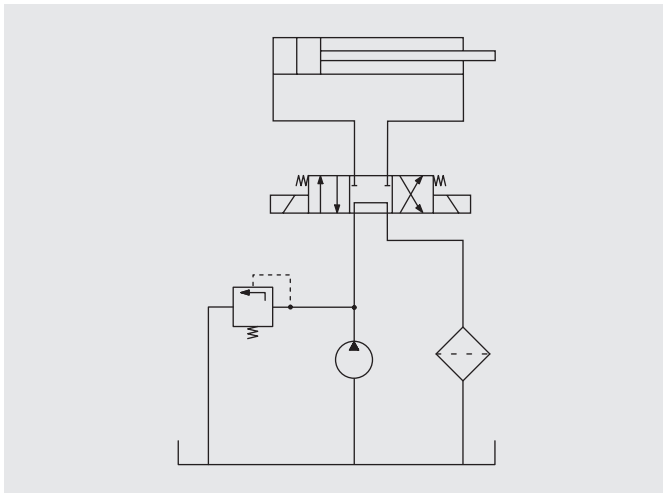

Figure 1: Hydraulic system with return filter

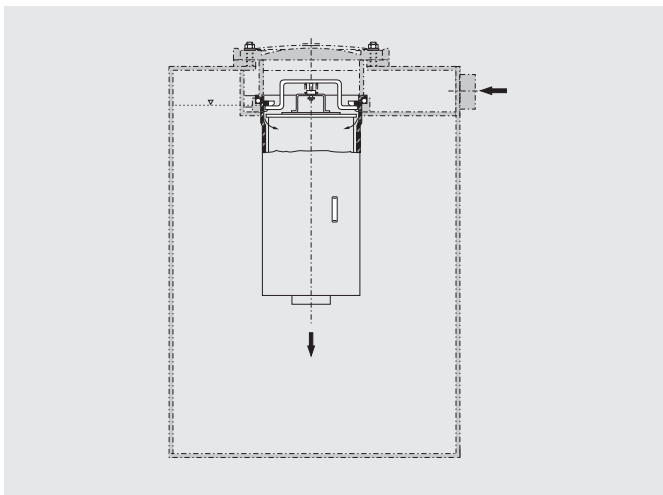

Figure 2: Return filter E 441 ... E 700 for installation in tanks



Figure 3: Return filter E 103 for tank installation with integrated tank ventilating filter

### Return filters

It is particularly beneficial to use filters that are mounted on the tank or integrated in it, because this method allows filtering of the entire oil flow (full flow filtration) at low cost and with low space requirements (Figure 1).

Full flow filtration in the return flow protects the pumps against dirt which penetrates the system from outside (especially via hydraulic cylinders) or which is generated by abrasion.

When selecting the right filter size, it is essential to consider the maximum possible flow rate. Depending on the area ratio between the piston and piston rod side of the hydraulic cylinder, this is larger than the flow rate for the pump(s) (for cylinders with single-ended piston rod).

Full flow filtering in the return may be problematic, and is therefore inadvisable. If the maximum flow rate is very high in relation to the pump flow rate (for example due to a large area ratio for the cylinders, and/or due to the emptying of hydro-accumulators).

The maximum pressure build-up (mainly determined by the actuating pressure and characteristic curve of the bypass valve) should be considered on the basis of these conditions:

- › if drain lines for pumps and/or hydro-motors are connected to the return filter system, the maximum pressure build-up specified for these components by the manufacturer must not be exceeded. (The limitation is usually on the sealing rings of the input/output shafts).
- › in certain cases where several components are connected in a system, high pressure build-up can trigger uncontrolled functions – for example, the hydraulic cylinders may be moved out unintentionally.

To prevent oil foaming in the tank, it is essential to ensure that the oil outlet is always below the oil level under all operating conditions. The distance from the tank bottom should be 2 to 3 x the diameter of the outlet (extension pipe diameter), in order to avoid swirling particles which have already settled on the bottom.

At a very early stage, ARGO-HYTOS pushed the consistent introduction of return filters for mobile units mounted below the tank surface, in a separate oil return chamber.

As long ago as 1971, ARGO-HYTOS was the first manufacturer to launch tankmounted return filters on the market, with integrated tank ventilating filter within the filter head (Figure 3).



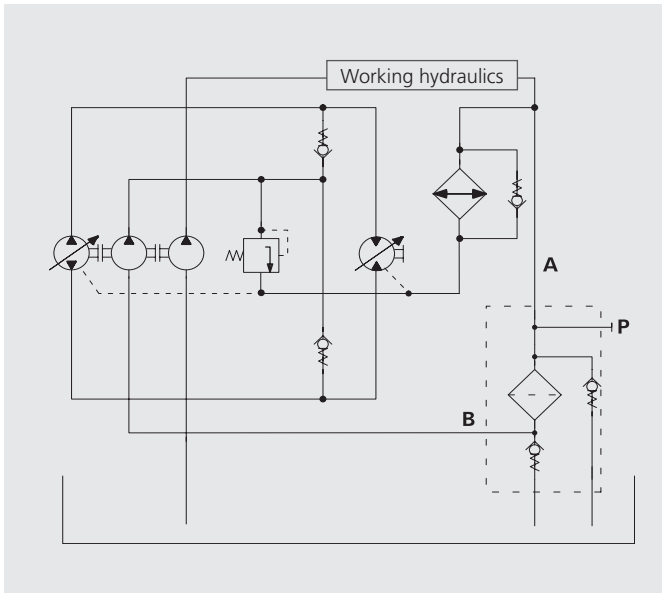

Figure 1: Hydraulic system with return-suction filter



Figure 2: ARGO-HYTOS return-suction filters

### Return-suction filters

ARGO-HYTOS first developed its return suction filters in the mid-1980's. On equipment with a hydrostatic drive and combined working hydraulics, these filters replace the suction and/or pressure filters that were previously required for the filling pump of the closed hydrostatic drive, and in an open circuit they replace the return filter for the working hydraulics (Figure 1).

The benefit of these filters is that filtered oil is fed to the filling pump at an overpressure of 0,5 bar, avoiding the risk of cavitation in the filling pump so that excellent cold start characteristics are possible.

In order to maintain a boost pressure of approx. 0,5 bar at the connection to the filling pump, a surplus between the return and suction flow is required under all operating conditions.

A pressure relief valve is used to feed the oil directly into the tank starting from a  $\Delta p$  of 2,5 bar (so no bypass for the closed circuit!).

If the drain oil from the hydrostatic drive is fed through the filter as well as the flow in the open circuit, remember that – in order to protect the radial shaft seals – the permissible drainline pressure must not be exceeded (taking account of the pressure drop in the drain lines, the oil cooler and the pressure relief valve on the filter).

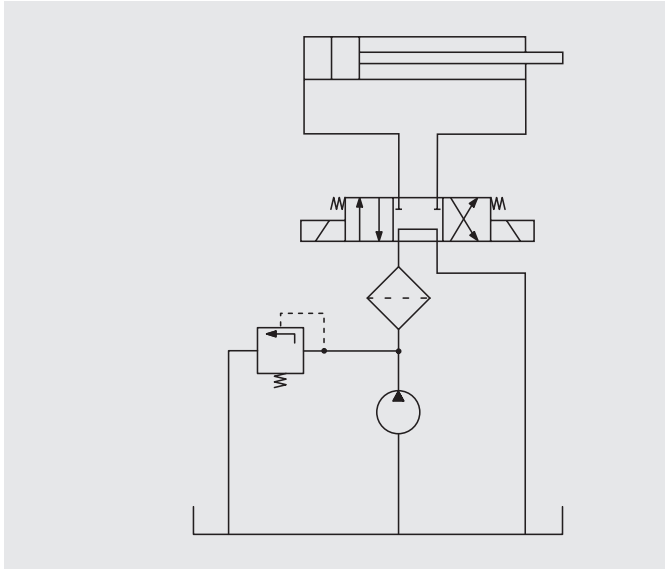

Figure 1: Hydraulic system with high-pressure filter



Figure 2: ARGO-HYTOS high-pressure filter HD 419

### Pressure and high-pressure filters

The main function of this type of filter is to ensure that the functions of downstream hydraulic components are protected. For this reason, these filters are installed directly upstream of the components if possible (Figure 1).

Taking account of the risks of dirt penetrating the system from outside and the possibility of pump abrasion, the following aspects can be particularly decisive for the use of a pressure or high-pressure filter:

- › the components are particularly sensitive to dirt (such as servo valves) and/or they are integral to the functioning of a complex system
- › the components are particularly expensive (such as large cylinders, servo valves, hydromotors) and they are extremely important for the safety of the equipment (such as hydraulic steering, transmission or brake systems)
- › exceptionally high costs are possible if a system is shut down due to malfunctions or damage to a hydraulic component caused by contamination.

High pressure filters must withstand the maximum system pressure, and in many cases the fatigue strength must also be guaranteed because there are frequent pressure peaks in the system.

ARGO-HYTOS is convinced that safety is very important. For example, casings must undergo a fatigue strength test before they are released for series production, and leakage tests are performed regularly during production.

In many cases, high-pressure filters carry out their function by filtering only part of the flow or only relatively coarse particles. In these cases, the filter basically operates as a safety filter. Under these conditions, a fine filter should be positioned at another point in the system so as to take account of the requirements for protection against wear.

High-pressure filters that mainly work as safety filters should preferably be equipped with a differential pressure switch that monitors the contamination of the filter element. Only high-pressure filters without a bypass valve should be fitted upstream of particularly critical components. Those filter types must be fitted with a high collapse filter element that itself is able to withstand higher differential pressure loads without damage.

In this case, a decisive influence on the maximum differential pressure is the ratio between startup viscosity  $v_2$  and operating viscosity  $v_1$ .

Assuming that the filter element is changed when the differential pressure indicator responds, the following formula can be used to determine the highest possible differential pressure that will occur on the element:

$$\Delta p_2 = \frac{v_2}{v_1} \times \Delta p_1$$

- $v_1$  = operating viscosity
- $v_2$  = start viscosity
- $\Delta p_1$  = max. differential pressure switch responds at operating viscosity  $v_1$
- $\Delta p_2$  = max. differential pressure at start viscosity  $v_2$

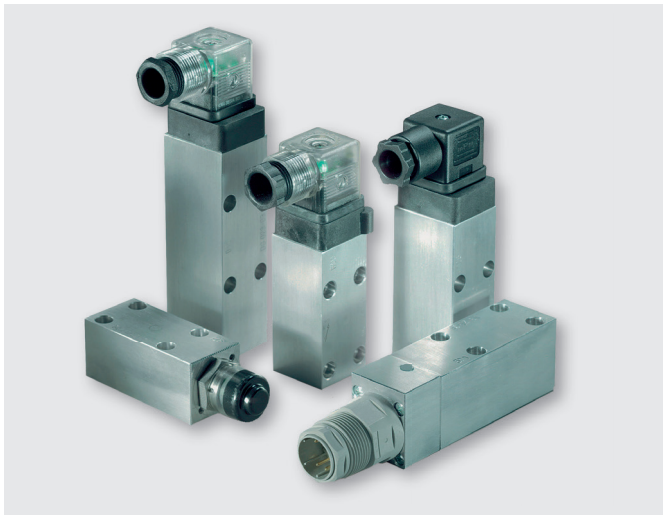

ARGO-HYTOS differential pressure indicators



ARGO-HYTOS pressure switches and manometers

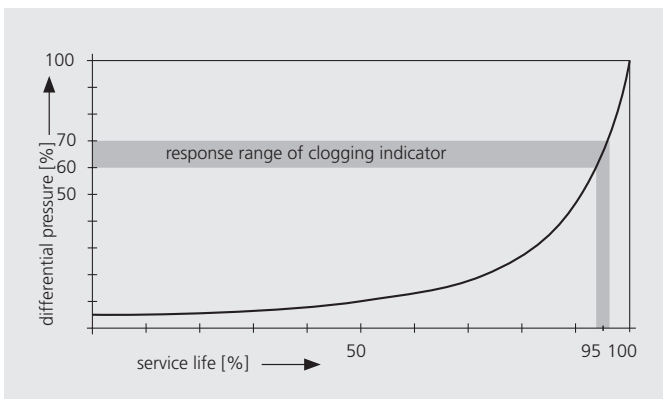

Typical progression of contamination of a filter element throughout its service life

Example of calculation:

- › operating viscosity  $\nu_1 = 35 \text{ mm}^2/\text{s}$
- › start viscosity  $\nu_2 = 700 \text{ mm}^2/\text{s}$
- › switching pressure of differential pressure switch =  $5 \pm 0,5 \text{ bar}$
- › max. differential pressure  $\Delta p_1 = 5,5 \text{ bar}$

$$\Delta p_2 = \frac{700}{35} \times 5,5 \text{ bar} = 110 \text{ bar}$$

The differential pressure which occurs here would be 110 bar. ARGO-HYTOS's EXAPOR®MAX 2-elements, with a collapse pressure of 160 bar, have been specially developed to meet these demanding requirements.

The EXAPOR®MAX 2-filter elements that are used in ARGO-HYTOS high-pressure filters without a bypass valve have a collapse pressure of 160 bar and they are stable in response to differential pressure, so they satisfy the highest safety requirements:

- › damage to the filter layer up to the specified differential pressure of 160 bar is impossible thanks to the exceptional support offered by the filter medium, together with its high intrinsic stability.
- › there is consistent monitoring of the manufacturing process for filter elements, with continuous checks on production quality to ISO 2942.

### Clogging indicators

As the duration of use of the filter element increases, the level of contamination and therefore the pressure drop will increase. This causes pressure build-up and/or differential pressure, which is monitored by the clogging indicator. When a preset value is reached, electrical and/or optical signals are given.

*The following points should be noted here:*

the pressure drop on the filter element increases with the flow rate, the contamination and the kinematic viscosity of the pressure fluid.

For these reasons, a filter element is only regarded as contaminated and in need of replacement when the contamination indicator responds at the operating temperature of the hydraulic system, and when the signal remains on continuously.

### Effects of delaying the replacement of a filter element:

*On filters with bypass valve:*

- › the more heavily the filter element is contaminated, the more frequently the bypass valve will respond, and part of the hydraulic fluid will not be filtered.

*On filters without a bypass valve:*

- › the pressure drop on the filter element, and hence the loss of efficiency in the system, will increase continuously: this can lead to impermissible heating of the hydraulic oil.

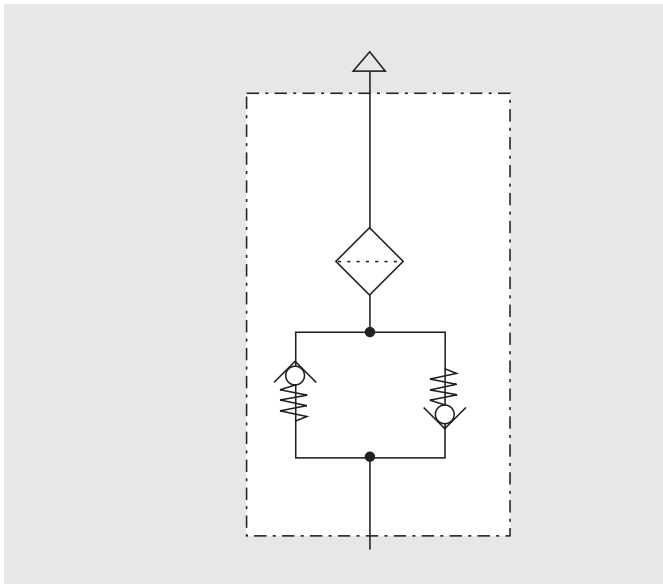

Figure 1: Circuit diagram for ventilating filters with double check valve



Figure 2: ARGO-HYTOS ventilating filters



Figure 3: ARGO-HYTOS Vandalism Proof ventilating filters

### Ventilating filters

Temperature changes, together with the use of cylinders and/or pressure accumulators, cause the oil level in the tanks of hydraulic systems to have constant fluctuations.

These create a difference in pressure with the surrounding environment, which is compensated by an exchange of air that can allow dirt to penetrate the tank.

A ventilating filter can prevent dirt from entering. Ideally, it should have at least the same fineness as the system filters in the hydraulic circuit.

Ventilating filters with double check valves can be used to achieve a major reduction in the exchange of air between the tank and the environment, so that the entry of dirt and dust is minimized and the service life of the ventilating filter element can be prolonged (Figure 1).

An important factor here is that the air volume in the tank and the valve cracking pressure must be optimally coordinated with the specific design of the system.

With the specified air volume in the tank, higher response pressures tend to cause a reduction in the exchange of air. The air exchange at the defined response pressure of the ventilating filter can be reduced by increasing the air volume.

With a suitable design, a defined pressure level can be generated in the tank in order to improve the suction conditions for the pumps.

A special feature: ARGO-HYTOS ventilating filters in the patented Vandalism-Proof version (Figure 3).

These ventilating filters can only be dismantled with a special spanner which is supplied with the product. This makes it considerably more difficult to remove the ventilating filter, or to pour dirt in through the filling/ventilation opening.

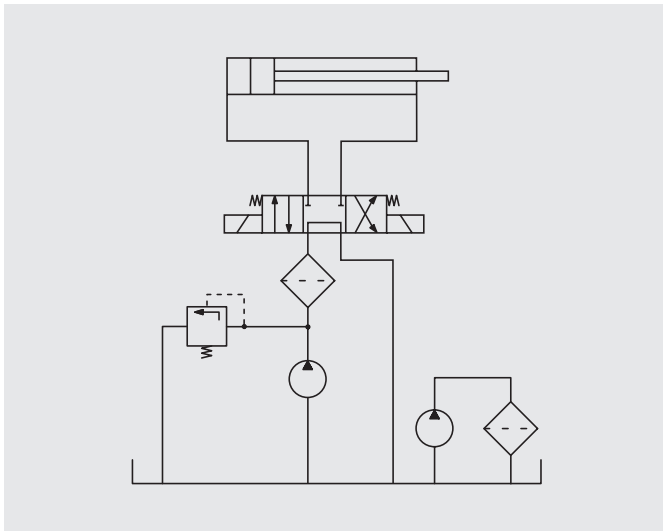

Hydraulic system with high-pressure filter and off-line filter unit



ARGO-HYTOS off-line filter unit with motor and pump



ARGO-HYTOS mobile filter unit with oil diagnostic system

### Off-line filters

Increasingly, additional off-line filters are being used in systems that are subject to high stress in order to prevent the build-up of superfine particles. Unlike main flow filters, off-line filters only filter part of the total flow in the system. Depending on the influence of the environment (incidence of dirt) and the selected filter fineness, the partial flow (in l/min) should be approx. 2 to 10 % of the tank volume (in l).

In combination with superfine filter elements, outstanding levels of oil cleanliness can be achieved by continuous filtration, independently of the machine's working cycle. Furthermore, the load on the main filters is reduced, so that intervals between replacements can be extended.

Off-line filter systems should be used in addition to main flow filters; in this case, the latter can be designed as protective filters, i.e. they do not filter so finely.

A distinction is usually made between two different concepts:

#### *Off-line filters with a flow control valve*

From the pressure circuit of the system, the required quantity of oil initially flows via an integrated flow control valve and then it is fed into the tank via the offline filter. The small installation effort for this concept makes it especially suitable for retrofitting systems.

#### *Off-line filter units*

From the pressure circuit of the system, the required quantity of oil initially flows via an integrated flow control valve and then it is fed into the tank via the offline filter. The small installation effort for this concept makes it especially suitable for retrofitting systems.

### Filter units

To guarantee the required level of oil cleanliness when a system is filled for the first time or refilled, the operating medium should be cleaned using filter units with superfine filter elements.

Mobile filter units are also suitable for cyclical cleaning of hydraulic or lubrication systems where no provision was made for off-line filters when the systems were equipped for the first time, and it is impossible to install them at a later stage.

Optimal results can be achieved if the cleaning and/or filling processes are monitored by an oil diagnosis system such as particle counters.

**Definition of the filter fineness**

The Multi-Pass test according to ISO 16889:1999 is used to determine the number of particles upstream and downstream of a filter, in relation to specified particle sizes. This makes it possible to calculate the respective beta value (the filtration ratio) which is the quotient of the numbers of particles upstream and downstream of the filter.

$$\text{Beta value } \beta = \frac{\text{number of particles upstream of filter}}{\text{number of particles downstream of filter}}$$

The filtration level (or filtration efficiency) can be calculated analogously.

$$\text{Filtration efficiency} = \frac{\text{no. of particles upstream of filter} - \text{no. of particles downstream of filter}}{\text{no. of particles upstream of filter}} \times 100 \%$$

The following relation exists between the two values:

$$\text{Filtration efficiency (in \%)} = \left(1 - \frac{1}{\beta}\right) \times 100 \%$$

The following table provides some numerical values.

Beta value $\beta$	1	1,5	2	5	10	20	50	75	100	200	1000	10000
Filtr. efficiency	0 %	33,33 %	50 %	80 %	90 %	95 %	98 %	98,67 %	99%	99,5 %	99,9%	99,99%

Relation between beta value and filtration efficiency

ARGO-HYTOS filter fineness is based on the mean beta value 200 ( $\beta_{x(c)} = 200$  according to ISO 16889:1999) corresponding to a filtration efficiency of 99,5%. The relevant characteristic filtration curves are shown in the chart.

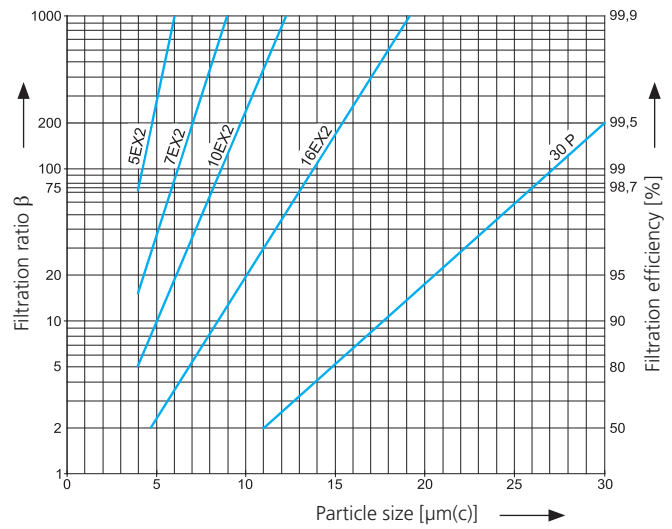

ARGO-HYTOS filter fineness: filtration ratio and filtration efficiency in relation to particle size to ISO 16889

This makes it easy to read the filtration ratio and the filtration efficiency in percent for various particle sizes, clearly showing the relationship between the various levels of fineness. The characteristics of the individual curves ultimately determine the level of cleanliness for the pressure fluid that can be achieved in practice.

### Oil cleanliness classification

The classification systems ISO 4406 and NAS 1638 are most widespread. Both systems are used to describe the distribution of solid particles in hydraulic fluids according to number and size.

This is done by assigning the number of particles of a specific size to a code number or class. Each time the oil cleanliness deteriorates by a class, the number of particles is doubled. This relationship is shown in the table, using ISO 4406 as the example.

No. of particles per 1 ml		Code number
from	up	
80.000	160.000	24
40.000	80.000	23
20.000	40.000	22
10.000	20.000	21
5.000	10.000	20
2.500	5.000	19
1.300	2.500	18
640	1.300	17
320	640	16
160	320	15
80	160	14
40	80	13
20	40	12
10	20	11
5	10	10
2,5	5	9
1,3	2,5	8
0,64	1,3	7
0,32	0,64	6
0,16	0,32	5
0,08	0,16	4
0,04	0,08	3
0,02	0,04	2
0,01	0,02	1

Extract from ISO 4406:1999

NAS 1638 uses different particle size ranges to describe the distribution of particles, whereas ISO 4406:1999 indicates the number of particles > 4 μm(c), > 6 μm(c) or > 14 μm(c) as codes.

The following chart shows the evaluation of an oil sample according to ISO 4406:1999.

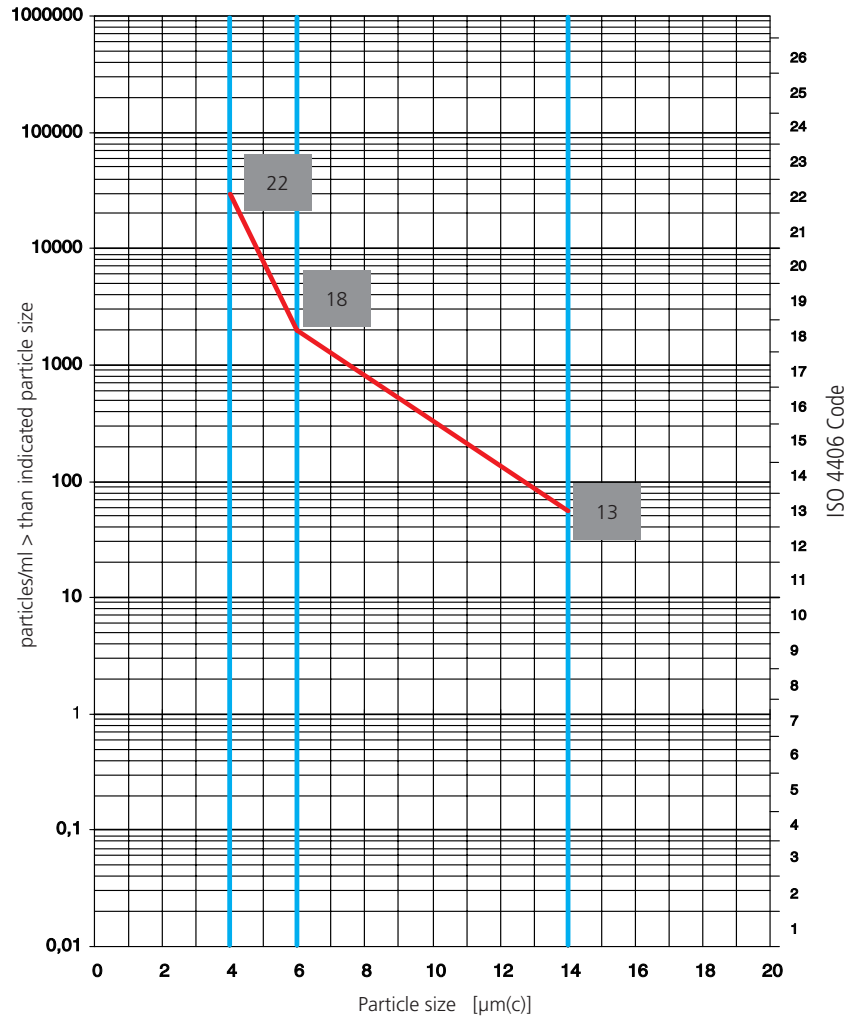

Evaluation of an oil sample according to ISO 4406:1999

<b>Pumps</b>	
Axial piston pumps	21 / 18 / 15
Radial piston pumps	21 / 18 / 15
Gear pumps	21 / 18 / 15
Vane pumps	20 / 17 / 14
<b>Motors</b>	
Axial piston motor	21 / 18 / 15
Radial piston motor	21 / 18 / 15
Gear motors	21 / 18 / 15
Vane motors	20 / 17 / 14
<b>Valves</b>	
Directional control valves (solenoid valves)	21 / 18 / 15
Pressure valves	21 / 18 / 15
Flow control valves	21 / 18 / 15
Check valves	21 / 18 / 15
Proportional valves	20 / 17 / 14
Servo valves	17 / 14 / 11
<b>Cylinders</b>	
	21 / 18 / 15

Figure 1: Oil cleanliness level required for hydraulic components (160 ... 210 bar)

Operating pressure	Change in oil cleanliness
0 ... 100 bar	3 classes worse
100 ... 160 bar	1 class worse
160 ... 210 bar	none
210 ... 250 bar	1 class better
250 ... 315 bar	2 classes better
315 ... 420 bar	3 classes better
420 ... 500 bar	4 classes better
500 ... 630 bar	5 classes better

Figure 2

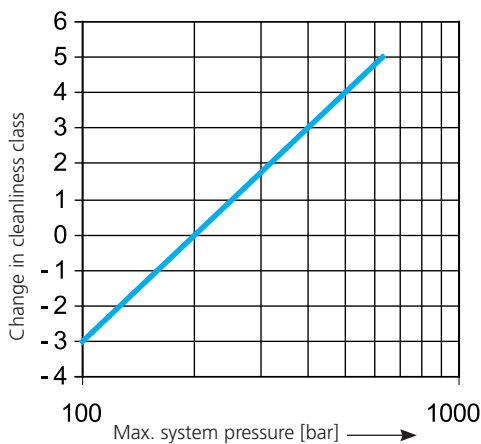

Figure 3: Influence of the operating pressure on required oil cleanliness

**Required oil cleanliness**

The oil cleanliness required in the system is determined by the component which is most sensitive to dirt. If the component manufacturer does not provide any specific information about the required oil cleanliness or filter fineness, it is advisable to determine the oil cleanliness on the basis of the adjoining tables (Figure 1.)

The listed reference values for normal components refer to a basic pressure range of 160 ... 210 bar.

If the operating pressure is increased in a system, it is necessary to improve the oil cleanliness in order to achieve the same wear lifetime for the components.

The adjoining table lists the required change in oil cleanliness when the operating pressure increases in relation to the basic pressure range of 160 ... 210 (Figure 2).

Using an example, we will now explain the influence of the operating pressure on the required oil cleanliness, and hence on the filter fineness.

In a system with gear pump and proportional valves, oil cleanliness of 20/17/14 to ISO 4406 is required for an operating pressure of up to 210 bar. If the operating pressure is raised to 250 bar, the table shows that the oil cleanliness must be improved by 1 class to 19/16/13.

The required oil cleanliness is determined by other influencing variables as well as the operating pressure:

- › expected lifetime of the machine
- › costs of repairs/spare parts
- › interruption costs due to shutdown times
- › requirements for the safety of the system (these are not only influenced by the cleanliness of the oil!)

If one of these aspects is especially important, the required oil cleanliness should be improved by one class. If two or more criteria apply, the required oil cleanliness must be up-graded by two classes.

In the example given above, if high-grade cylinders are used as well, and if high interruption costs can be expected due to a system shutdown, 17/14/11 should be recommended as the oil cleanliness class instead of 19/16/13 (2 classes better).



**Required ARGO-HYTOS filter finenesses**

Continuous evaluation of oil samples for several decades has shown which level of oil cleanliness can be achieved with which filter fineness under specified system conditions. For full flow filtration under the least favorable conditions, cleanliness levels to ISO 4406:1999 can be achieved with ARGO-HYTOS filter finenesses as follows:

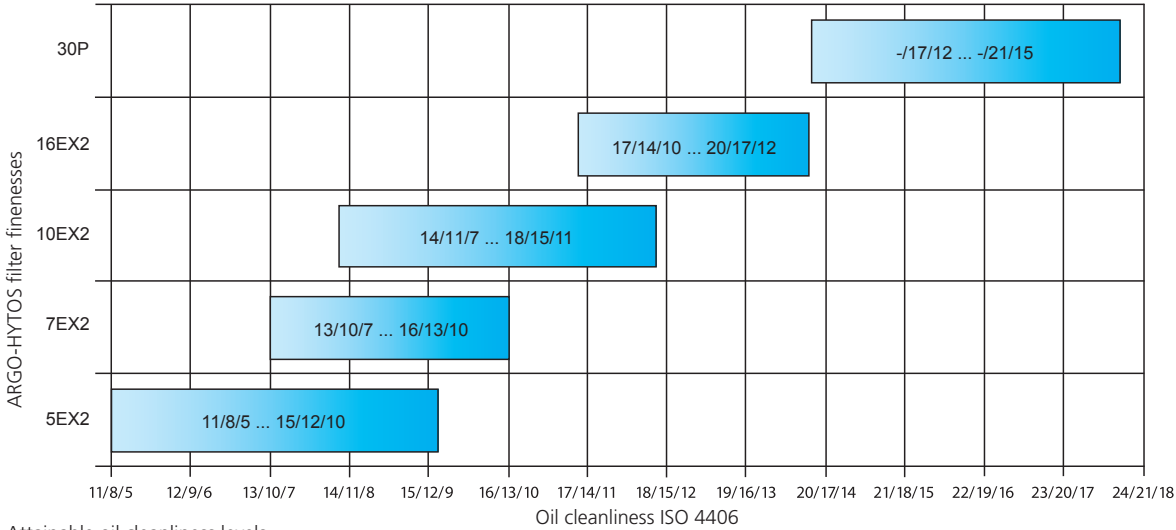

Attainable oil cleanliness levels

However, significantly better levels of oil cleanliness can be achieved depending on the environmental conditions and the specific circumstances of the system. Conditions that may have a positive influence on the cleanliness level include:

- › design features that reduce the penetration of dirt from outside (high-quality packing seals in hydraulic cylinders, good shaft sealing rings)
- › tank ventilating filters with fine filter elements
- › uniform flow instead of pulsation (caused by variable displacement pumps, for example)
- › low pressure drop, e.g. when suction filters or off-line filters are used

Depending on the influence of one or more of the criteria mentioned above, the oil cleanliness levels that are achieved will be at the left end of the bandwidths shown (in favorable cases) or at the right end (in unfavorable cases).

In the calculation example cited previously, an oil cleanliness level of 19/16/13 was required. Now we shall determine which ARGO-HYTOS filter fineness is required to achieve this.

According to the chart, filter fineness 16EX2 can be used to achieve oil cleanliness of 17/14/10 in the most favorable case. But under unfavorable conditions, it will only be possible to attain class 20/17/12. On the other hand, filter fineness 10EX2 can achieve the required oil cleanliness of 19/16/13 even under the most unfavorable conditions.

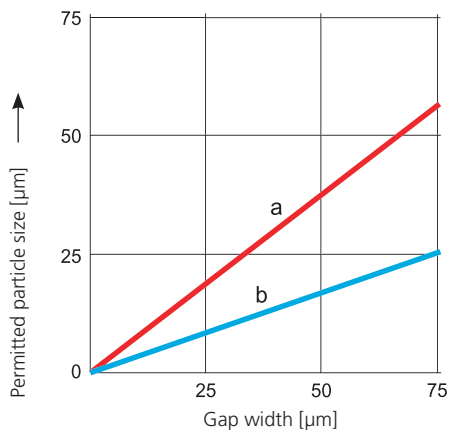

Permitted particle size in relation to gap width with (a) large and (b) small relative movement of the gap surfaces.

**Fineness required to prevent gap blockage**

Typical phenomena that cause functional failures on hydraulic components include blockage of gaps and nozzles. Flow control valves, restrictor valves and servo valves are particularly susceptible to this problem. If the relative movement of the gap surfaces is small, there is a greater risk that the gap will clog up when the size of the dirt particles exceeds 1/3 of the smallest gap height (characteristic b in the chart below). Bearing the possibility of blockage in mind, this means that the absolute filter fineness must be at least equal to the given value, or better less than this value. The adjoining chart shows how the gap width and the permitted particle size are related.

### Nominal flow rate

The correct choice of filter size, taking account of application-specific operating conditions, is the only way to ensure that:

- › economically acceptable filter lifetimes are achieved
- › even with higher starting viscosity, 100% filtering guarantee – the best possible functional protection for the hydraulic components, with pressure drops in the system kept to a minimum

These important criteria must be taken into account when the nominal flow of a hydraulic filter is determined.

- › in practical operating conditions, the filter service life must be at least 1000 operating hours (for this purpose, ARGO-HYTOS's operational experience shows that a specific dirt accumulation of at least 0,07 g per l/min flow rate has to be taken as a basis).
- › at nominal flow rate, the bypass valve of the filter must remain closed during first startup (new filter element) up to a starting viscosity of 200 mm<sup>2</sup>/s (see the following chart). This corresponds to a temperature of approx. 15 °C with an ISO VG 46 or HLP 46 hydraulic oil.

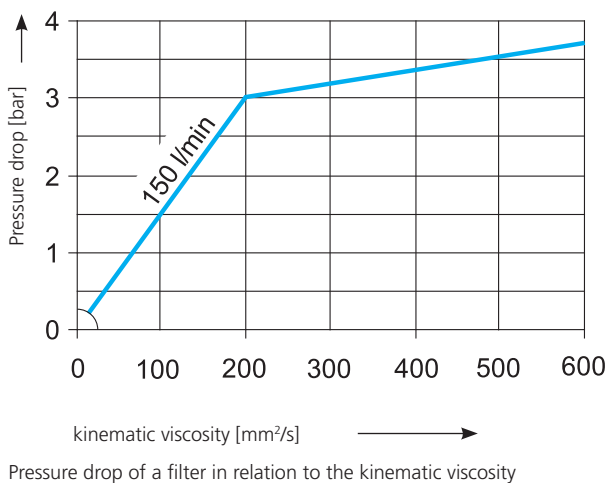

Given that the pressure drop on superfine filter elements is more or less proportional to the kinematic viscosity, the approximate permitted flow rate on a filter for pressure fluids that vary from ISO VG 46 can be determined as follows:

$$Q_{\max} = Q_N \times \frac{v_1}{v_2}$$

$Q_{\max}$  = permitted maximum flow with a pressure fluid that varies from ISO VG 46

$Q_N$  = nominal flow rate based on ISO VG 46

$v_1$  = kinematic viscosity of the ISO VG 46 pressure fluid at 15 °C (corresponds to 200 mm<sup>2</sup>/s)

$v_2$  = kinematic viscosity of the variant pressure fluid at 15 °C

When using hydraulic oils of higher viscosity, a lower flow rate is permitted as compared with the nominal flow rate. For media of lower viscosity, on the other hand, a higher flow rate is possible as compared with the nominal flow rate. The below listed flow rates have to be adhered to.

When hydraulic oils of different viscosity classes are used, this results in the following factors for  $Q_N$ :

ISO viscosity class	Factor for $Q_N$
22	2,60
32	1,60
46	1,00
68	0,60
100	0,38
150	0,23
220	0,14
320	0,09

The following flow speeds in pipes and hoses should not be exceeded:

- › suction line: 1,5 m/s
- › return line: 4,5 m/s
- › pressure line up to 100 bar: 6 m/s
- › pressure/high-pressure line up to 250 bar: 8 m/s
- › high-pressure line up to 600 bar: 12 m/s

All nominal flow rates indicated by ARGO-HYTOS are based on the criteria listed before, which have been fully tried and tested in practice.

### How to determine the required dirt capacity

In many cases, the user indicates either the required filter lifetime in operating hours (Bh in the formulas) or the dirt capacity in grams of ISO MTD.

If the lifetime is specified (usually it is identical to the intervals between replacements according to the operating and maintenance instructions), a safety factor of 1,2 to 2,0 should be applied in order to calculate the required ISO MTD capacity of the filter element.

The safety factor is based on the importance or weighting of criteria such as

- › nature of influences from the environment (dust, moisture, temperature)
- › following the maintenance instructions (original spare parts, oil quality, intervals between replacements)
- › filter monitoring by electrical/optical indicators
- › preventive replacement of filter elements

The required setpoint dirt capacity in grams ISO MTD is calculated according to this formula:

$$\text{Dirt capacity}_{\text{setpoint}} = \frac{\text{Specified lifetime}}{1000 \text{ Bh}} \times S \times \text{SPS} \times Q$$

- Specified lifetime = desired filter lifetime in operating hours (Bh)  
 S = safety factor (1,2 ... 2,0)  
 SPS = specific dirt ingestion in g/l/min/1000Bh  
 Q = pumped flow rate of the working pump in l/min

### SPS values

SPS = specific dirt ingestion, indicated in g/l/min pumping flow in 1000 operating hours.

In the Multi-Pass test, the dirt capacity of a filter is determined with the help of a test dust whose chemical and physical characteristics cannot be compared to those of dirt that occurs in practice. The filter lifetimes that can actually be achieved in various hydraulic systems under practical conditions can only be determined by extensive investigations in the field. The SPS value represents the relationship between the dirt capacity determined in the Multi-Pass test and the filter lifetime that can be achieved in practice. SPS values for commonly used hydraulic systems are shown in the chart.

These experience-based values refer to a machine concept with a well-protected hydraulic cylinder and highly efficient tank ventilating filters.

For systems and equipment that are not included in this list, please consult ARGO-HYTOS for the relevant SPS value.

### How to determine the lifetime

The calculated dirt capacity should now be compared with the ISO MTD values shown in the ARGO-HYTOS data sheets, taking account of the filter fineness that has already been determined, and the nominal flow rate.

If the selection table shows that the dirt capacity of the selected filter varies substantially from the calculated value, it may be necessary to select the next largest type. If the variance is insignificant, the decision is ultimately up to the user. The lifetime in hours can then be determined as follows:

$$\text{Lifetime}_{\text{actual}} = \frac{\text{Dirt capacity}_{\text{actual}}}{S \times \text{SPS} \times Q} \times 1000 \text{ Bh}$$

If the result varies substantially from the specified lifetime, you should again verify the initial data and safety factors, and check whether the system has been classified in the correct machine group based on the SPS value.

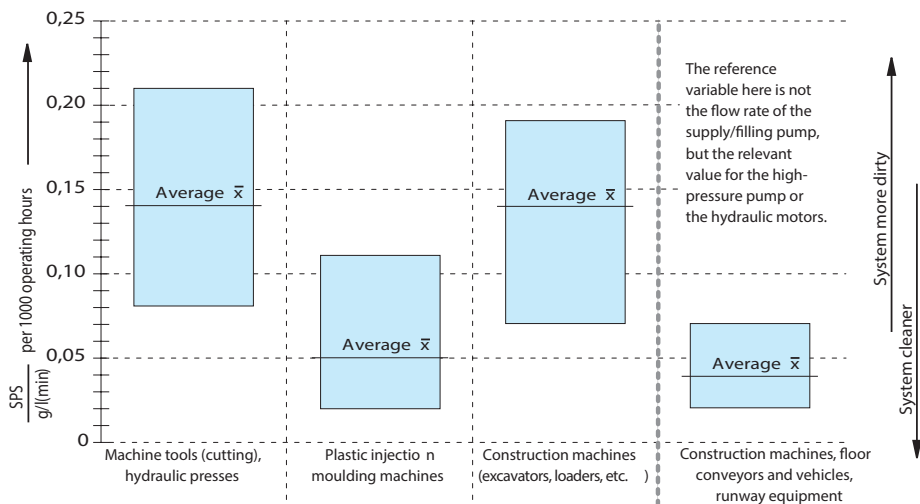

SPS values for typical hydraulic systems

## Further considerations



Clogging indicators



High-pressure filters with flanged / threaded connection

Before you finally determine the hydraulic filter that is suitable, you should also clarify these points:

### Design-related factors:

- › accessibility for changing the filter element
- › type of clogging indicator
- › positioning/dimensions of the oil tank
- › level differences/angles
- › connection threads/flanges

### Hydraulic factors:

- › type of fluid
- › level/number of possible pressure peaks
- › pressure drop at nominal flow
- › viscosity
- › electrical conductivity
- › bypass valve required/allowed

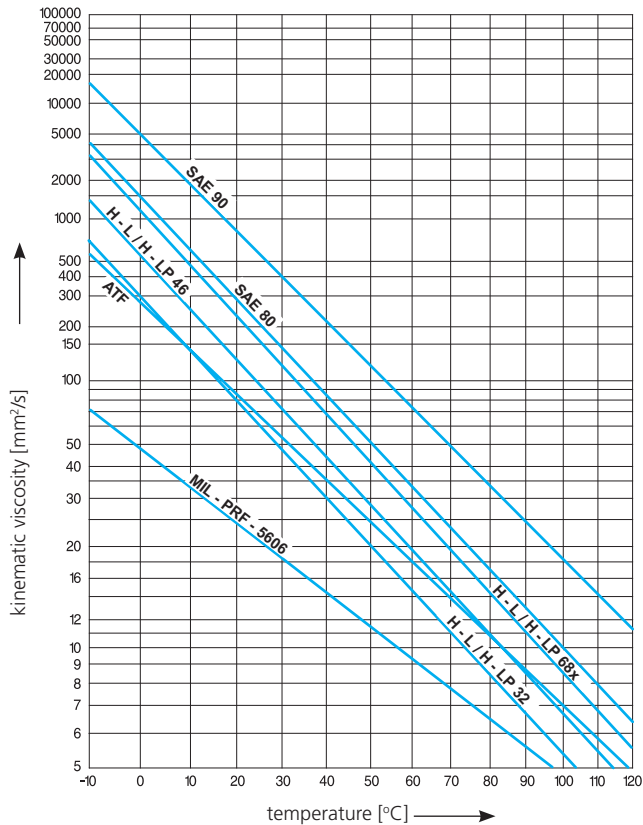

Viscosity

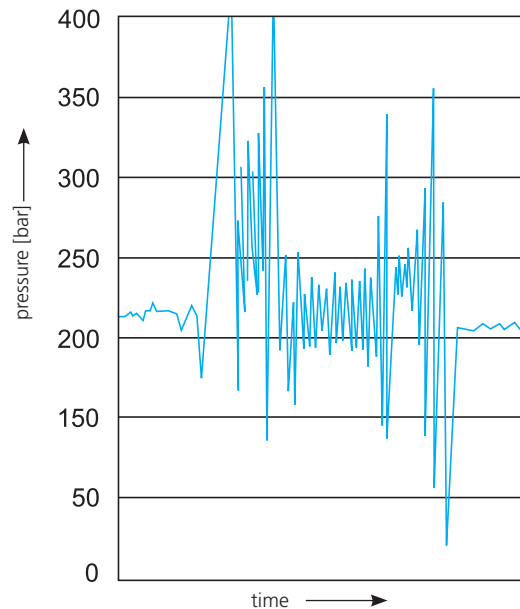

Pressure peaks

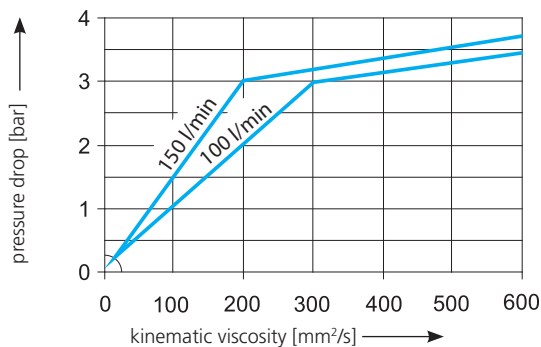

Pressure drop

We are certain that these "Guidelines" have provided you with some important information and that they will help you to reach a decision.

However, the "Guidelines" cannot be a substitute for personal advice from our qualified filter specialists, nor are they intended as such.

## Flow chart filter selection procedure

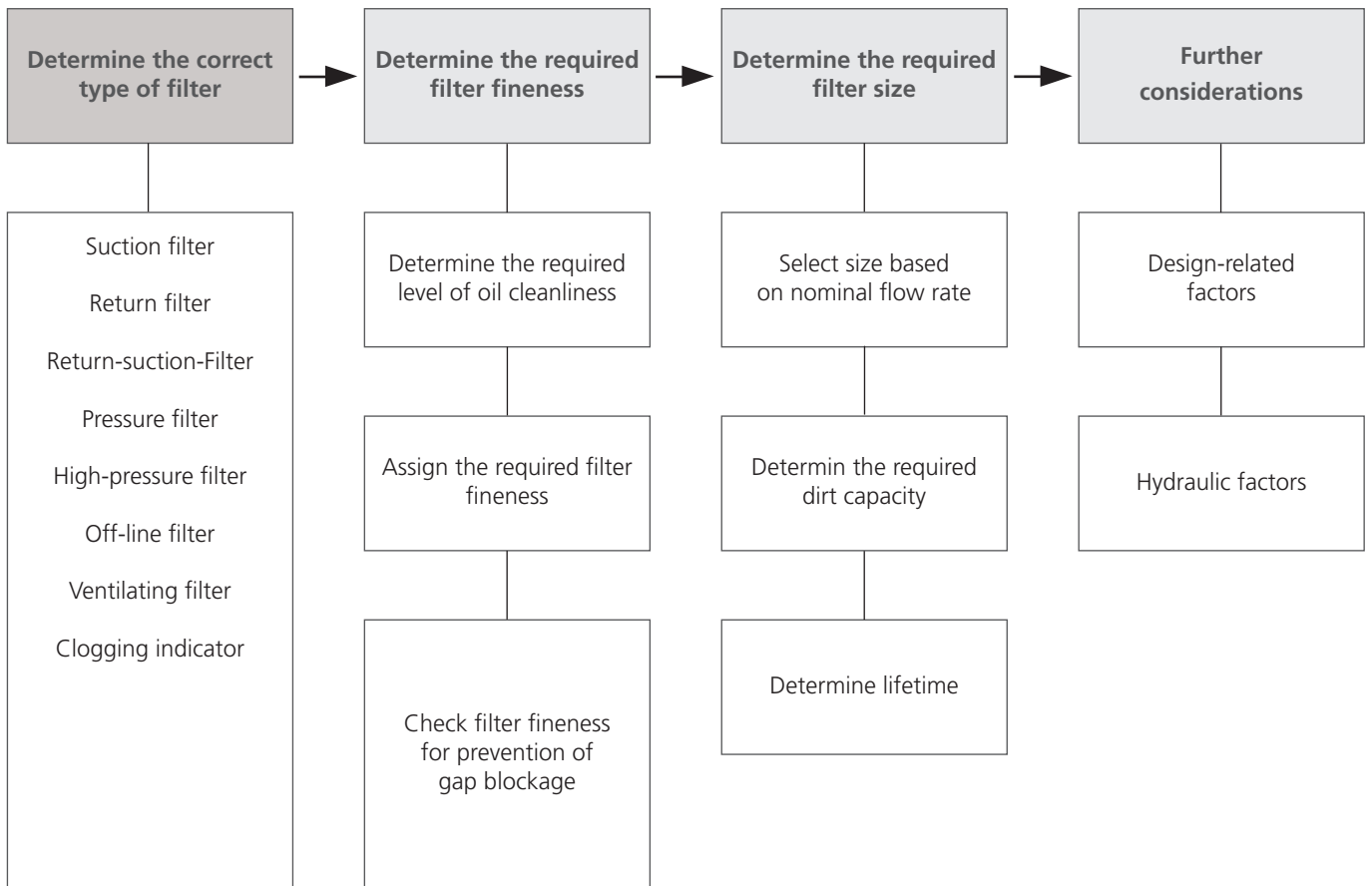

International

## ARGO-HYTOS worldwide

<b>Benelux</b>	ARGO-HYTOS B. V.	info.benelux@argo-hytos.com
<b>Brazil</b>	ARGO-HYTOS AT Fluid Systems Ltda.	info.br@argo-hytos.com
<b>China</b>	ARGO-HYTOS Fluid Power Systems (Yangzhou) Co., Ltd. ARGO-HYTOS Fluid Power Systems (Beijing) Co., Ltd. ARGO-HYTOS Hong Kong Ltd.	info.cn@argo-hytos.com info.cn@argo-hytos.com info.hk@argo-hytos.com
<b>Czech Republic</b>	ARGO-HYTOS GMBH ARGO-HYTOS Protech s.r.o	info.cz@argo-hytos.com info.protech@argo-hytos.com
<b>France</b>	ARGO-HYTOS SARL	info.fr@argo-hytos.com
<b>Germany</b>	ARGO-HYTOS GMBH.	info.de@argo-hytos.com
<b>Great Britain</b>	ARGO-HYTOS PVT. Ltd.	info.uk@argo-hytos.com
<b>India</b>	ARGO-HYTOS PVT. LTD.	info.in@argo-hytos.com
<b>Italy</b>	ARGO-HYTOS srl	info.it@argo-hytos.com
<b>Poland</b>	ARGO-HYTOS Polska sp. z o.o.	info.pl@argo-hytos.com
<b>Russia</b>	ARGO-HYTOS LLC	info.ru@argo-hytos.com
<b>Scandinavia</b>	ARGO-HYTOS Nordic AB	info.se@argo-hytos.com
<b>Turkey</b>	ARGO-HYTOS	info.tr@argo-hytos.com
<b>USA</b>	ARGO-HYTOS Inc.	info.us@argo-hytos.com

